

JUNE 2023

# J&K CABINETS





---

# J&K CABINETRY



Pearl Glazed / H9

“Kitchen Is The Heart  
Of Your Home”

---

# CON TE N

06  
HISTORY

08  
OUR CABINETS

10  
KITCHEN

30  
BATHROOM

36  
HIDDEN EXPRESSIONS

38  
DECOR

40  
ENVIRONMENTAL COMMITMENT

41  
FINEST FURNITURE FINISHES

42  
SUPERIOR CONSTRUCTION

43  
STANDARD FEATURES

44  
WARRANTY

46  
MAINTENANCE & CARE

E  
E  
E  
T  
S



---

# HISTORY OF J&K CABINETS

---



J&K Cabinetry was founded in year 2003 with the goal of providing customers with the highest quality of cabinets available at an affordable price. For the past 20 years, J&K has been providing distinctive and stylish line of kitchen cabinets and bathroom vanities, and it continues to grow today as a unique cabinet brand. One of the keys to the continued success lies in its commitment to continually improve both the product quality and the design style with customers' needs in mind.



By focusing on the excellent craftsmanship and the unique designs, J&K Cabinetry offers a more personalized experience for all customers and homeowners when they choose their dream kitchens.

---

## OUR CABINETS

---

All of J&K's cabinets and vanities are ready-to-assemble (RTA), ready-to-build (RTB), and semi-customizable to the customers' specific needs. J&K products are constructed with 100% solid wood doors and frames, 1/2" to 5/8" thick plywood boxes, soft-close metal door hinges, 3/4 to full extension drawers with soft-close metal glides, and more.



By making all these “optional upgrades” a necessary standard, the overall quality, functionality, durability, and value of J&K products are significantly improved without adding the burden of higher prices for the customers.

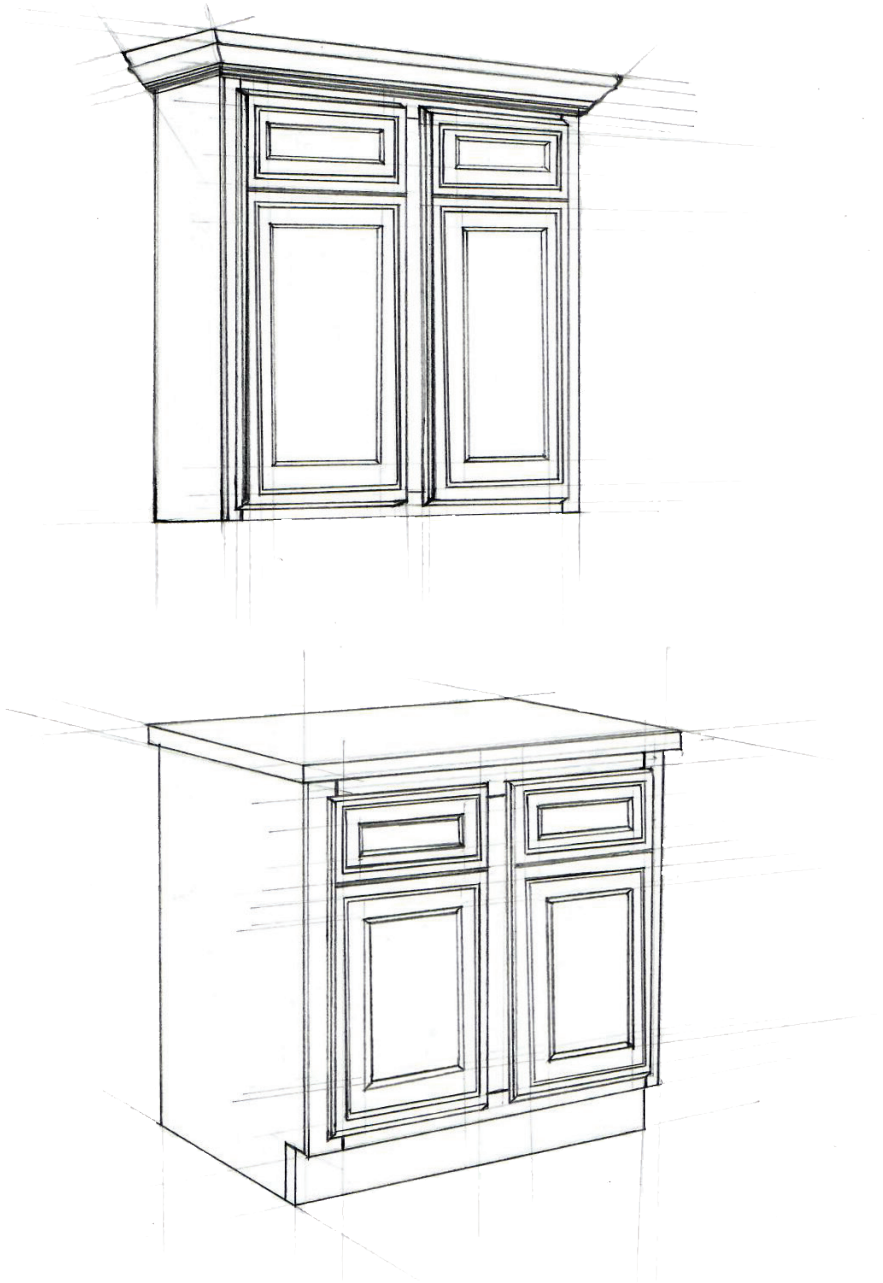

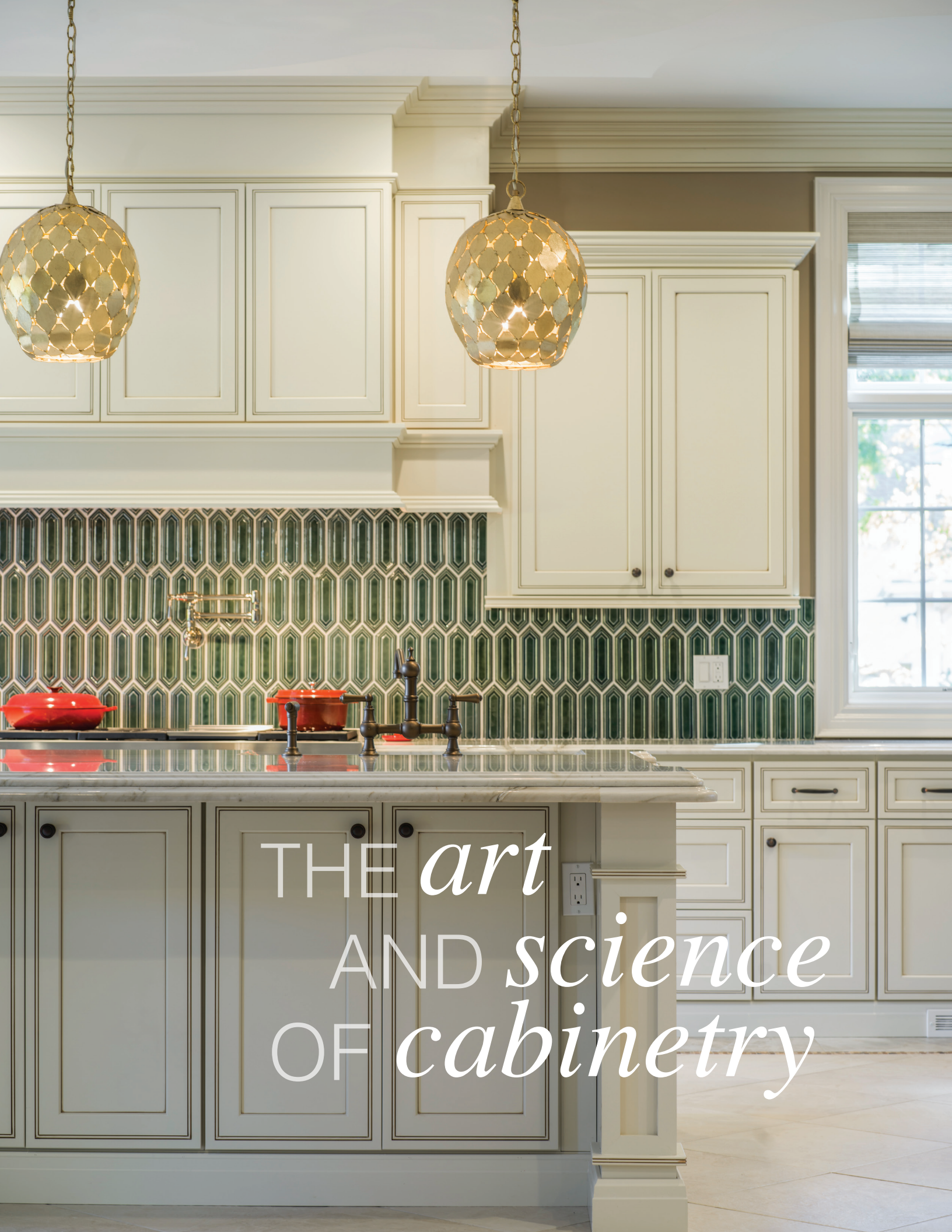

THE *art*  
AND *science*  
OF *cabinetry*

---

Welcome to your dream

KITCHEN™

---



White / S8

# CONTEMPORARY



**S8**  
White



**S5**  
Castle Grey

*Note: Constructed with ALL-WOOD reversed raised panel door for S8, S5.*

**Note:** Availability for a particular product style and color may vary depending on locations. Please check with your local J&K Cabinetry authorized wholesaler for current availability before planning your projects.



LOOK FOR THE DREAM THAT KEEPS COMING BACK.



The simple and clean lines of shaker cabinets allows them to fit perfectly in any traditional or contemporary kitchen designs.

## S-Series

Contemporary  
White / S8

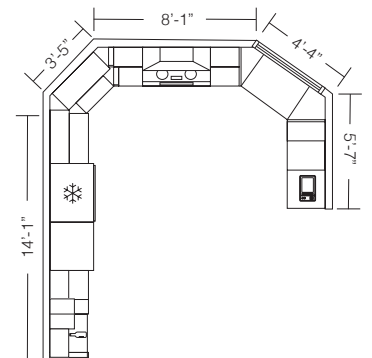



Semi-customized drawer base cabinets for built-in microwave



Full front overlay dishwasher door panel

Enclosed space for built-in wine cooler







Contemporary cabinetry creates  
its own reflection of the time

# S-Series

Contemporary  
Castle Grey / S5

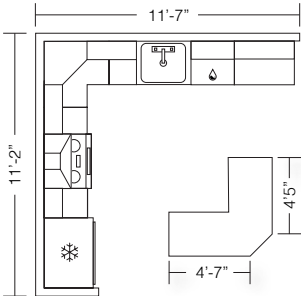



CABINETRY THAT ADDS A MODERN  
FEEL TO YOUR HOME DECOR

---

## Style & Elegance

---







*Redefine Your Expectations....*

# TRANSITIONAL



**E1**  
Dove



**E2**  
Charcoal



**K3**  
Greige

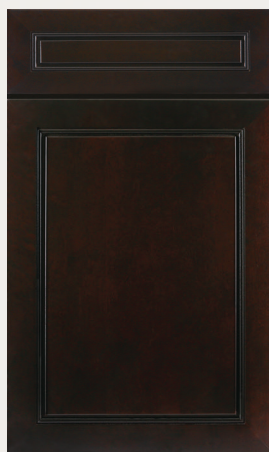

**K8**  
Espresso



**H9**  
Pearl Glazed

*Note: Constructed with plywood center panel door for E1, E2.*







# H-Series

Transitional  
Pearl Glazed / H9

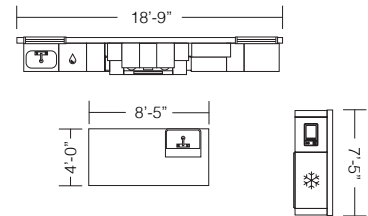





# K-Series

Transitional  
Greige / K3

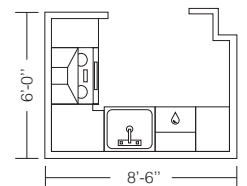
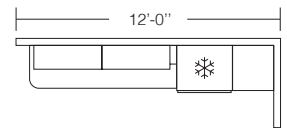



Mocha Glazed / K10

TRADITIONAL



**K10**  
Mocha Glazed

**Note:** Availability for a particular product style and color may vary depending on locations. Please check with your local J&K Cabinetry authorized wholesaler for current availability before planning your projects.

---

Welcome to your dream

# BATHROOM™

---

A  
Perfect  
Blend of  
Style  
& Color





Experience  
Luxury  
At Home







Pearl Glazed / H9

Find your  
Vision of  
The perfect  
Bath



---

# Hidden Expressions

---

Wine Rack



Roll-Out Tray



Lazy Susan



Sink Base Tilt-Out Tray

# Decor

Acanthus Corbel



Large Acanthus Corbel



Twisted Split Turn Post



Crown Molding

---

# Environmental Commitment

---



J&K Cabinetry believes that a healthy environment is the backbone to the happy lives of our customers and our society. In addition to its continued effort to improve product qualities and values, J&K is committed to providing environmental-friendly and healthy products.

J&K products' hardwood-plywood materials are "EPA TSCA Title VI Compliant," also known as "CARB 2 Compliant" for formaldehyde. J&K also uses AkzoNobel, a leading global company in sustainable paints and coatings, for its cabinet finishes.



**AkzoNobel**





---

# Finest Furniture Finishes

---

J&K's solid wood cabinet finishes are processed through the following excellent craftsmanship details:

1. The finest solid wood is sanded until smooth and vacuumed.
2. An equalizer stain is applied to balance the base color of the wood.
3. A toner is applied to establish color uniformity.
4. A deep penetrating stain is applied to reveal the hidden beauty of the natural grain.
5. All stained surfaces are hand-rubbed and wiped of excess stain and then slowly air-dried.
6. A wood sealer is applied, penetrating all exposed wood surfaces for uniform protection.
7. All surfaces are hand-sanded, providing a smooth, consistent surface.
8. A glaze is applied by hand (if applicable).
9. A color consistency examination is performed with additional touch-ups, if needed.
10. A final protective top coat is applied, maximizing resistance to scuffing, moisture, fading and most household chemicals.



**Notes:**  
NOT Actual Product;  
Image For Reference Only.

## Natural Wood Characteristics:



Arce

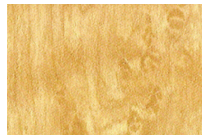

Burl Grain

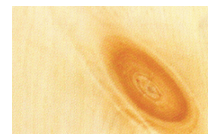

Open Knots



Bird's Eye



Mineral Streaks

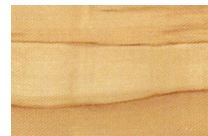

Heartwood

**Note:** All solid wood may contain natural "imperfections," such as variations in color, grain, mineral streaks and knots.

**\*Note:** Natural wood characteristics such as gum pockets, streaks and pin knots may be visible, particularly with some of our light paints. These characteristics tend to be more pronounced on the the backs of our drawers and doors.

---

# Superior Construction

---



**Wall Cabinet** with two doors in Castle Grey (S5).

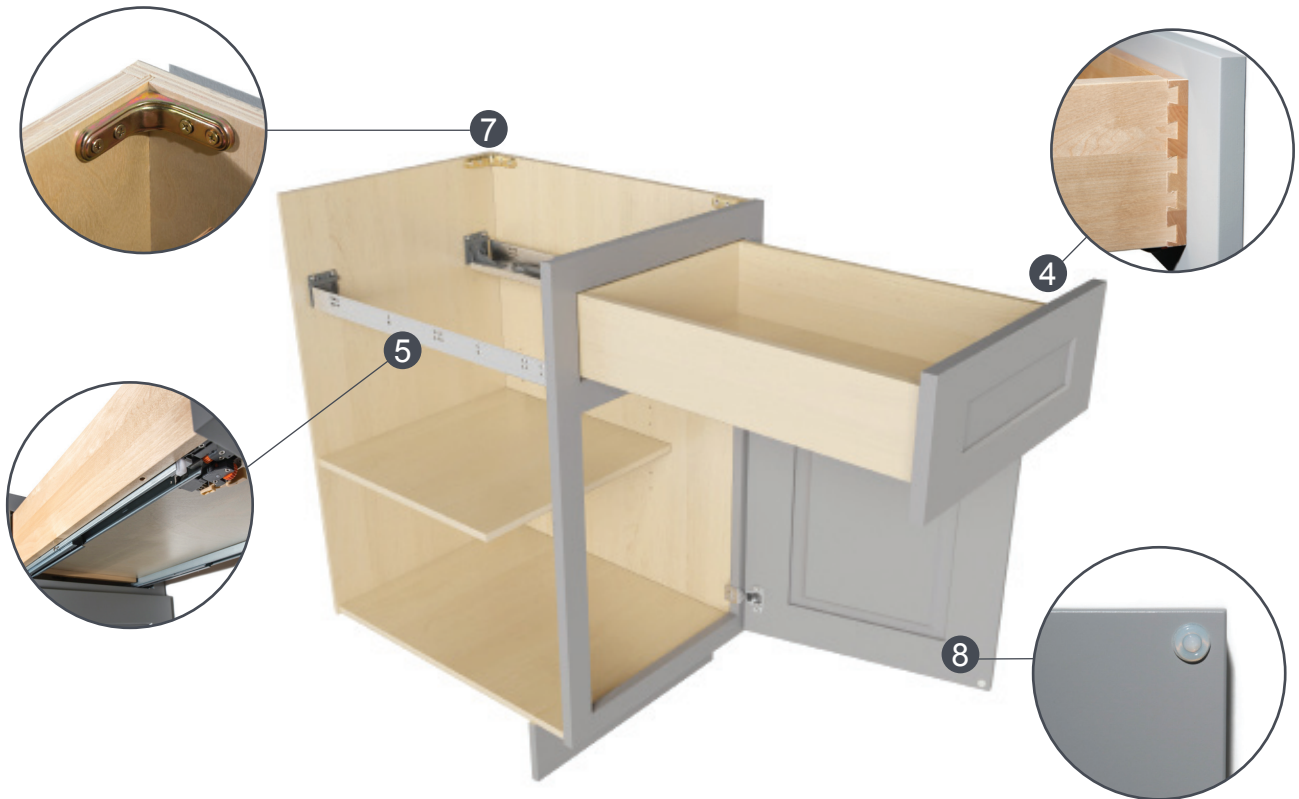

**Base Cabinet** with one drawer and one door in Castle Grey (S5).

---

# Standard Features

---

All J&K's cabinets and vanities are superiorly constructed with 100% solid wood and proudly come with the following **STANDARD** features:

1. **DOOR PANEL** – 3/4" thick solid wood, full overlay door.
2. **DOOR HINGE** – 6-way adjustable, soft-close metal and hidden Euro-style.
3. **ADJUSTABLE SHELF** – 3/4" thick cabinet-grade plywood, clear coat finish on all sides and edges; with metal shelf rests.
4. **DRAWERS** – 5/8" thick solid wood on all sides, dovetail construction.
5. **DRAWER GLIDE** – 3/4 to Full extension pull-out, soft-close metal and concealed under-mount.
6. **PLYWOOD BOX** – 1/2" to 5/8" thick cabinet-grade plywood, clear coat finish on interior sides; matching color finish on exterior sides.
7. **METAL BRACKET** – Corner bracket reinforcements in base cabinets for maximum stability.
8. **DOOR BUMPER** – Promotes quiet-closing and reduces slamming for maximum durability.

Tilt-out Trays have been another upgrade and STANDARD feature in all of J&K's Kitchen Sink Base and Vanity Sink Cabinets.



## NOTE:

As we continue to improve our product qualities and designs, the actual functionality of Door Hinges and Drawer Glides may vary slightly between existing and newest product styles and finishes. Please check with your local J&K Cabinetry authorized wholesaler for the most current updates.



---

# J&K FIVE YEAR LIMITED WARRANTY

---

- J&K CABINETS ("J&K") extends the following limited warranty on all cabinets manufactured and sold by J&K within the United States and Canada. This Limited Warranty is only applicable to products sold to the original purchasing consumer on or after January 1, 2019. J&K warrants that all cabinets purchased from J&K will be free from all unnatural defects in material and workmanship in accordance with J&K quality standards sheet under normal residential use for 5 years from the date of the original purchase or as long as the original purchasing consumer owns the home in which such cabinets are installed, whichever is less. This warranty is non-transferable to subsequent owners of the home. Door hinges and all drawers glide system, including system hardware (lift system), however, are warranted for only 1 year under normal residential use from the date of the original purchase.

**THIS LIMITED WARRANTY IS SUBJECT TO ALL LIMITATIONS, EXCLUSIONS, DISCLAIMERS, AND PROCEDURES SET FORTH HEREIN.**

- The warranty does not cover defects caused by improper handling, storage, dirt, chemicals, abrasive or citrus cleaning products, installation, assembly or disassembly, transit or other intentional or negligent damage, product modifications, exposure to the extreme moisture, humidity or excessive heat or cold (temperature outside the range of 50-85°F and humidity outside the range of 30-55% are considered extreme), nor does it cover defects arising from normal wear and tear, misuse, neglect, accidents, alterations, improper use, exposure to improper loads, or failure to maintain properly. Any modification to the hardware structure or finish of the original consumer purchaser's cabinetry by anyone other than those specifically authorized by J&K to do so shall void this limited liability warranty. The product must be used exclusively for its intended purpose in order to be covered by this limited liability warranty. This limited liability warranty shall become void if the cabinets or any components or parts thereof are in any way modified, improperly installed or damaged prior to or during installation, or installed or used in other than normal residential applications.
- Natural woods may vary in color, grain pattern, and characteristics and exhibit subtle changes as they age. Wood characteristics that naturally occur, such as variations in color, grain, mineral streaks and knots, are not considered defects. J&K will not be held responsible for these variations in your cabinetry. For example, painted doors, drawer fronts, and face frames may eventually have visible cracking around the joint area, and cabinet colors may darken or lighten over time. These conditions are considered a normal occurrence and are not included or covered by this limited liability warranty. A glazed finish by character is an uneven finish. Some edges and profiles will have heavier hang up than others and glazing may vary cabinet to cabinet, door to drawer and item to item. This may result in overall color variations but is not considered a defect. UV light, Sunlight, smoke, household cleaners, and other environmental conditions may also affect the color and integrity of the Product's finish or appearance over time. These variations are considered to be the nature of the material in relation to their environmental exposure and are not considered defects in material or workmanship and are not covered under this Limited Warranty.
- Mitered door joints in particular are likely to react to conditions of their environment. Gaps that may develop in door joints due to conditions of their environment are not included or covered by this limited liability warranty. This limited liability warranty does not cover or apply to hairline cracks of cabinetry; hairline cracks are unavoidable in wood cabinets given the nature of the material. Every species and grade of solid wood behaves in such a way as to eventually result in hairline cracks.
- Wood is wood and expansion and contraction still happen year after year as it compensates and adjusts to ever changing atmospheric humidity and temperature conditions. Observing shrink, expansion on center panels of doors is very common. It will return to its natural position within couple months once it has adjusted to seasonal changes. For the same reason, all door warpage greater than 1/4" will be warranted. Please remove all doors and check them on a flat surface for the above stated warpage before requesting replacement.

- **Warranty Performance.** J&K periodically updates and makes changes to its product line and specifications. If a warranty claim is filed during the warranty period against obsolete or changed product and repair is not possible, J&K will, at its sole option, repair or replace the part under warranty with a new part of the same style or with a similar style currently offered and does not include or cover any other costs, including but not limited to any costs of service, labor, shipment, transportation, removal or installation related to the repair or replacement. J&K is not responsible for a replacement product that may not match the installed product exactly. If a manufacturing defect occurs within this limited liability warranty's terms and conditions and J&K determines to replace the defective cabinet or component or part thereof, J&K will ship the replacement cabinet or component or part thereof to the original consumer purchaser via ground shipper or freight carrier, at J&K's sole discretion.

**DISCLAIMER OF OTHER WARRANTIES:**

THIS WRITING IS THE COMPLETE AND EXCLUSIVE REMEDY FOR ANY ORIGINAL CONSUMER PURCHASER. FOR BREACH OF WARRANTY. THE STATEMENT OF THE EXPRESS WARRANTIES PROVIDED HEREIN IS IN LIEU OF ANY AND ALL OTHER EXPRESS AND/OR STATUTORY WARRANTIES, TO THE EXTENT PROVIDED BY LAW. IN NO EVENT SHALL J&K BE LIABLE FOR INCIDENTAL OR CONSEQUENTIAL DAMAGES TO ANY ORIGINAL CONSUMER PURCHASER OR A THIRD PARTY, INCLUDING BUT NOT LIMITED TO DAMAGES ARISING FROM PERSONAL INJURY, LOST PROFITS, LOSS OF BUSINESS OPPORTUNITIES, LOSS OF PROPERTY, ECONOMIC LOSS, STATUTORY OR EXEMPLARY DAMAGES, WHETHER FROM NEGLIGENCE, WARRANTY, STRICT LIABILITY OR OTHERWISE. ANY AND ALL IMPLIED WARRANTIES OF MERCHANTABILITY, FITNESS FOR A PARTICULAR PURPOSE, COURSE OF DEALING AND USAGE OF TRADE, AND ANY AND ALL OTHER WARRANTIES, EXPRESS OR IMPLIED, ARE EXCLUDED AND DISCLAIMED, EXCEPTING ONLY THOSE EXPRESS WARRANTIES SPECIFICALLY SET FORTH IN THIS LIMITED LIABILITY WARRANTY. IN NO EVENT SHALL J&K BE LIABLE FOR ANY INDIRECT DAMAGES RESULTING FROM INSTALLATION, USE OR FAILURE OF ITS PRODUCTS. THIS LIMITED LIABILITY WARRANTY IS J&K'S SOLE WARRANTY, AND NO DEALER, DISTRIBUTOR OR AGENT POSSESSES ANY AUTHORITY WHATSOEVER TO MODIFY OR ENLARGE THIS WARRANTY IN ANYWAY. SOME STATES DO NOT ALLOW LIMITATIONS ON HOW LONG AN IMPLIED WARRANTY LASTS, SO THE ABOVE LIMITATION MAY NOT APPLY TO YOU.

**CLAIMS:**

To file a warranty claim, first contact your locally authorized J&K builder, dealer or distributor who installed and sold the J&K product. They will obtain the information necessary to make a claim decision and forward such information in writing to J&K. A dated sales receipt as proof of purchase is also required to obtain benefits from these warranties. At its discretion, J&K may require an inspection of the allegedly defective product before repairing or replacing. If you have difficulty obtaining assistance, please write at the address noted at bottom of page, with an explanation of the defect. Please do not send the allegedly defective cabinet or component or part thereof to J&K, unless and until expressly requested to do so by our claims department. Pictures of cabinets or components or parts thereof may be requested by J&K. Making a fraudulent claim may be a crime, and violators may be prosecuted. J&K reserves the right to make all final decisions regarding warranty claims.

This limited liability warranty and its enforcement, and any and all claims or disputes arising out of, relating to or in connection with this limited liability warranty or the making, performance or interpretation of this limited liability warranty, shall be (1) governed by and construed exclusively in accordance with the laws of the State of New York, without regard to the conflicts of law or choice of law principles of the State of New York or any other jurisdiction (including but not limited to U.S. federal law) that would require the application of the law of any other jurisdiction, and (2) brought only in the United States District Court for the District of Southern District of New York or the New York Supreme Court, Nassau County.



---

# MAINTENANCE & CARE

---

## General Information:

- As a general rule, keep all cabinet surfaces dry at all times.
- Cabinet surfaces shall be dried immediately with a soft, lint-free cotton cloth.
- Avoid using a dish cloth or sponge. Avoid ammonia-based cleaners and soaps with dye. Harsh detergent residues may harm cabinet finishes.
- As with all wood products, quick temperature changes and excessive moisture can be harmful to the cabinet finish and overall cabinet stability.

## Basic Cleaning:

- To remove dust after installation and for initial cleaning, use a soft, lint-free cotton cloth to wipe down all exterior and interior surfaces.
- For regular basic cleaning, use a soft, lint-free cotton cloth dampened with a mild detergent or soap and warm water. For best results, use a blotting action rather than a wiping motion, when cleaning.
- Wipe up food spills and water spots immediately with a lint-free cotton cloth, so moisture is not absorbed into the cabinet surfaces.

## Cleaning of Glass Door Inserts:

- Use a household glass cleaner with a soft, clean cloth.
- Apply the glass cleaner directly to the cleaning cloth rather than on the glass or mirror.
- Avoid excess glass cleaner running into the cabinet joints.
- Ammonia should never be used in full strength.

## Basic Care & Things to Avoid:

- When in doubt of a cleaner's suitability, DO NOT USE.
- Never use scouring pads, steel wool, wire brushes or powdered cleansers.
- Never leave a cloth moistened with cleaner on any cabinet surface for any length of time.
- Check the areas around the sink and dishwasher to make sure that water and detergents do not dry on the cabinet surfaces.
- Avoid draping wet or damp dish towels over doors of the base cabinets.
- Do not attach towel racks to the interior of cabinet doors.
- Avoid placing small kitchen appliances where the heat or steam is directed onto cabinet surfaces.
- Do not leave printed materials (newspapers, magazines, etc.) on the cabinet surfaces, as the printing can bleed into the cabinet finish.

**\*Note:** The photography and color samples shown in this catalog have been reproduced as accurately as printing technologies permit and are for representation only. To ensure the highest satisfaction, we strongly recommend you view an actual product sample prior to ordering cabinetry.

## **JKCABINETRYNC.COM**

### **J&K Cabinetry NC LTD**

A | 3071 Business Park Dr, Raleigh, NC 27610

T | 1-919-872-3830

F | 1-919-872-4506

E | sales@jkcabinetrync.com

*\*Authorized J&K CABINETRY Wholesaler.*